



5W Fixed Blade USB Charger - US



Features

- Fixed Blade
- Halogen Free
- Low Profile
- Low Cost
- No Y Caps
- US DoE Level VI Compliance

Applications

- Smart Phones
- PDAs
- Personal Electronics
- Digital Cameras

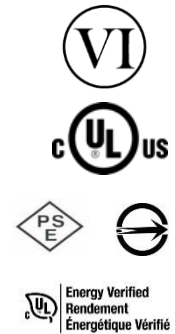



PSA05A Specifications¹

Model		PSA05A-050QL6-H	PSA05A-050QL6W-H ²
Output	DC Output Voltage	5.0V	
	Max Current	1.0A	
	Output Power	5.0W	
	Regulation	± 5%	
	Ripple & Noise P-P(max) ³	200mV	
Input	AC Input Voltage Range	90 to 264VAC	
	AC Input Frequency	47 to 63Hz	
	Input Current	0.15A(RMS) max	
	No Load Power Consumption at 115VAC Input	0.02W	
	No Load Power Consumption at 230VAC Input	0.027W	
	115VAC Average Efficiency ⁴	78.00%	
	230VAC Average Efficiency ⁴	76.20%	
	Leakage Current	5uA max	
Protection	Over-Voltage	10.0V max	
	Short Circuit	Auto restart	
Environmental	Operating Temperature	0°C to +40°C	
	Non-Operating Temperature	-40° to +85°C	
	Operating Humidity	90% RH max	
Safety Approvals and EMC	Dielectric Withstand (HI-POT)	Primary to Secondary: 3000VAC for 1min, 10mA	
	Insulation Resistance	Primary to Secondary: 10M ohm for 500VDC	
	Standards	cULus 62368-1, PSE, BSMI	
	EMI Emissions	FCC Part 15 Class B, CAN ICES-003(B)/NMB-003(B), EN 55032/CISPR 32 Class B Conducted and Radiated	
	Harmonic Current Emissions	IEC 61000-3-2	
	Voltage Fluctuations & Flicker	IEC 61000-3-3	
	Immunity	EN 55024/CISPR 24: IEC 61000-4-2 (Contact: +/- 4KV, Air: +/- 8KV), IEC 61000-4-3, IEC 61000-4-4, IEC 61000-4-5 (+/- 1kV), IEC 61000-4-6, IEC 61000-4-8, IEC 61000-4-11	
Mechanical	Dimensions (L x W x H)	59.0mm (2.32in) x 43.0mm (1.69in) x 21.0mm (0.83in)	
	DC Output Connector	USB-A	
	Case Color	Black	White
Notes	<ol style="list-style-type: none"> The specifications defined are at ambient temperature of 25C, unless otherwise specified. Special order item. Minimum order quantity applies. 20MHz bandwidth frequency oscilloscope, add a 0.1µF multilayer Cap. and Low ESR Electrolytic Cap. (10µF) at output connector terminals (nominal line voltage, full load). Efficiency is measured after 30 minutes burn-in. 		



PSA05A Outline Drawing

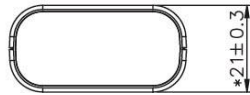
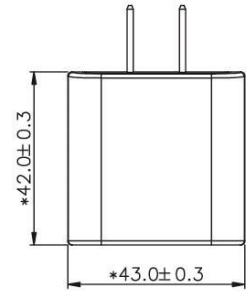
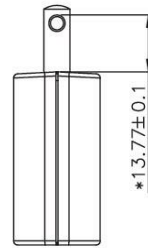
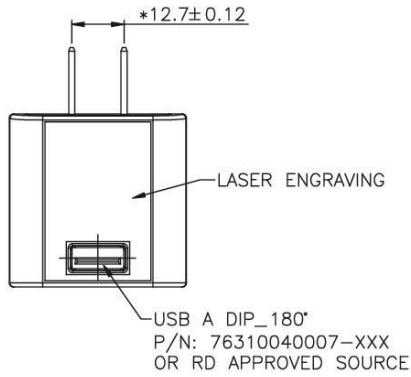
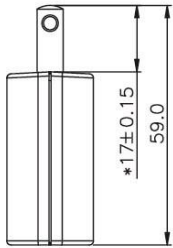
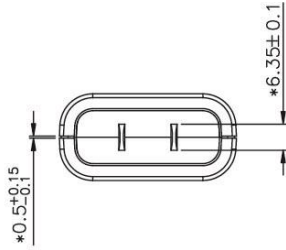



**Supplier's Declaration of Conformity
47 CFR § 2.1077 Compliance Information**

Phihong USA Corporation
47800 Fremont Boulevard
Fremont, CA 94538
Telephone: (510) 445-0100
www.phihong.com

This device complies with/The devices in this product series comply with part 15 of the FCC Rules. Operation is subject to the following two conditions: (1) This device may not cause harmful interference, and (2) this device must accept any interference received, including interference that may cause undesired operation.



USB Cables – Sold Separately

Unit: mm

Part no: IP-USB1(C10)S	Desc: USB-A to Micro-B – 1 Meter – Black
Part no: IPUSB1CS	Desc: USB to Mini-B – 1.5 Meter – Black
Part no: IPUSB1MS	Desc: USB-A to Micro-B – 1.5 Meter – Black
Part no: IPUSB1M5LD	Desc: USB-A to Micro-B – 24AWG – Low Drop – 1.5 Meter – Black
Part no: IPUSB1P5	Desc: USB-A to Micro-B – 1 Meter – 24AWG – Black
Part no: IPUSB1P5W	Desc: USB-A to Micro-B – 1 Meter – 24AWG – White

Part no: IPUSB1MSW	Desc: USB-A to Micro-B – 1.5 Meter – White
Part no: UES-1001A160	Desc: Low Drop Type-C USB Cable – 1 Meter – 23AWG on Power – 30AWG on Data - Black
Part no: UES-1003A160	Desc: Low Drop Type-C USB Cable - 1 Meter – 23AWG on Power – 30AWG on Data - White