



10W F-Series Interchangeable Plug Adapter Series



Features

- Folding Blades
- 15mm Thick with Blades Folded
- Constant Current for Battery Charging
- US DoE Level VI Efficiency Compliance
- Ecodesign/ErP Lot 7 (EU) 2019/1782 Compliance
- Interchangeable Clips (sold separately)

Applications

- Tablets
- Personal Electronics
- Networking Equipment
- Peripherals



PSA10F-050Q Specifications¹

Model		PSA10F-050Q-R ^{2,1}	PSA10F-050Q(D)-R ^{2,1, 2,2}
Output	DC Output Voltage	5.0V	
	Max Current	2.0A	
	Output Power	10.0W	
	Regulation	± 5%	
	Ripple & Noise P-P(max) ³	200mV	
Input	AC Input Voltage Range	90 to 264VAC	
	AC Input Frequency	47 to 63Hz	
	Input Current	0.3A RMS max @120VAC, 0.15A RMS max @240VAC	
	Inrush Current	60A at 240VAC	
	No Load Power Consumption at 115VAC Input	0.066W	
	No Load Power Consumption at 230VAC Input	0.083W	
	115VAC Average Efficiency ⁴	80.54%	
	230VAC Average Efficiency ⁴	80.05%	
	230VAC 10% Load Efficiency ⁴	70.84%	
	Leakage Current	100uA max at 240VAC	
Protection	Over-Voltage	6.3VDC max. Auto-restart	
	Short Circuit	Must withstand continuous short circuit	
Environmental	Operating Temperature	0°C to +40°C	
	Non-Operating Temperature	-40° to +85°C	
	Operating Humidity	10 to +90%	
Safety Approvals and EMC	Dielectric Withstand (HI-POT)	Primary to Secondary: 3000VAC for 1min, 10mA	
	Insulation Resistance	DC 500V, >7M ohm	
	Standards	cULus 62368-1, IEC 62368-1, PSB	
	EMI Emissions	FCC Part 15 Class B, CAN ICES-003(B)/NMB-003(B), EN 55032/CISPR 32 Class B Conducted and Radiated	
	Harmonic Current Emissions	IEC 61000-3-2	
	Voltage Fluctuations & Flicker	IEC 61000-3-3	
	Immunity	EN 55035/CISPR 35: IEC 61000-4-2 (+/- 8kV air, +/- 4kV contact), IEC 61000-4-3, IEC 61000-4-4, IEC 61000-4-5 (+/- 1kV), IEC 61000-4-6, IEC 61000-4-8, IEC 61000-4-11	
Mechanical	Dimensions (L x W x H)	60.0mm (2.36in) x 47.0mm (1.85in) x 15.0mm (0.59in)	
	Weight	38.5g	
	AC Input	US fixed blade folding prong	
	DC Output Connector	USB-A	

Model		PSA10F-050Q(S)-R ⁵
Output	DC Output Voltage	5.0V
	Max Current	2.0A
	Output Power	10.0W
	Regulation	± 5%
	Ripple & Noise P-P(max) ³	200mV
Input	AC Input Voltage Range	90 to 264VAC
	AC Input Frequency	47 to 63Hz
	Input Current	0.3A RMS max @120VAC, 0.15A RMS max @240VAC
	Inrush Current	60A at 240VAC
	No Load Power Consumption at 115VAC Input	0.066W
	No Load Power Consumption at 230VAC Input	0.083W
	115VAC Average Efficiency ⁴	80.54%
	230VAC Average Efficiency ⁴	80.05%
	230VAC 10% Load Efficiency ⁴	70.84%
Leakage Current	100uA max at 240VAC	
Protection	Over-Voltage	6.3VDC max. Auto-restart
	Short Circuit	Must withstand continuous short circuit
Environmental	Operating Temperature	0°C to +40°C
	Non-Operating Temperature	-40° to +85°C
	Operating Humidity	10 to +90%
Safety Approvals and EMC	Dielectric Withstand (HI-POT)	Primary to Secondary: 3000VAC for 1min, 10mA
	Insulation Resistance	DC 500V, >7M ohm
	Standards	cULus 62368-1, IEC 62368-1, PSB
	EMI Emissions	FCC Part 15 Class B, CAN ICES-003(B)/NMB-003(B), EN 55032/CISPR 32 Class B Conducted and Radiated
	Harmonic Current Emissions	IEC 61000-3-2
	Voltage Fluctuations & Flicker	IEC 61000-3-3
	Immunity	EN 55035/CISPR 35: IEC 61000-4-2 (+/- 8kV air, +/- 4kV contact), IEC 61000-4-3, IEC 61000-4-4, IEC 61000-4-5 (+/- 1kV), IEC 61000-4-6, IEC 61000-4-8, IEC 61000-4-11
Mechanical	Dimensions (L x W x H)	60.0mm (2.36in) x 47.0mm (1.85in) x 15.0mm (0.59in)
	Weight	38.5g
	AC Input	US fixed blade folding prong
	DC Output Connector	USB-A
Notes	<ol style="list-style-type: none"> The specifications defined are at ambient temperature of 25°C, unless otherwise specified. <ol style="list-style-type: none"> Data Lines (Pins 2 and 3) Shorted D model output to compensate for voltage drop in the USB cable by 400mV at full load 20MHz bandwidth frequency oscilloscope, add a 0.1µF multilayer Cap. and Low ESR Electrolytic Cap. (10µF) at output connector terminals (nominal line voltage, full load). Efficiency is measured after 30 minutes burn-in. Special order item. Minimum order quantity applies. Model output to compensate for voltage drop in the USB cable by 400mV and has termination resistors suitable for Apple products* *Apple is a trademark of Apple Corporation; Divider Mode Charging (2V to Pin2, 2.7V to Pin3) 	



PSA10F-050Q Outline Drawing

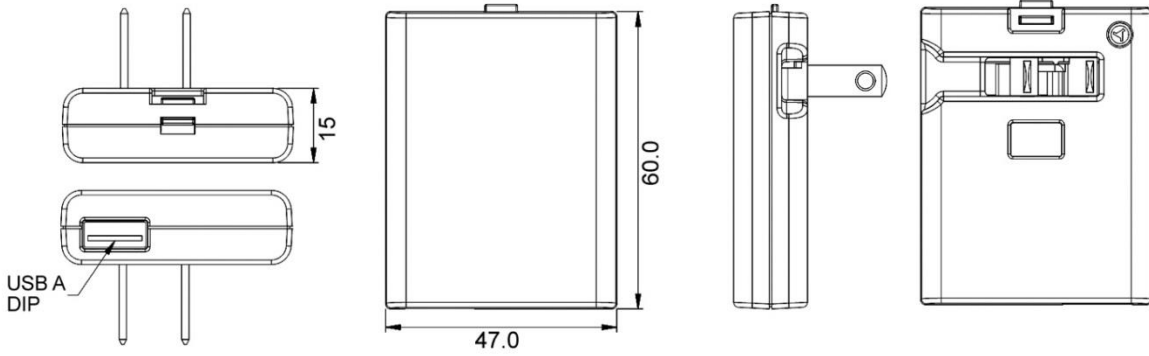

Supplier's Declaration of Conformity
47 CFR § 2.1077 Compliance Information

Phihong USA Corporation
47800 Fremont Boulevard
Fremont, CA 94538
Telephone: (510) 445-0100
www.phihong.com





NOTE: This model has/The models in this product series have been tested and found to comply with the limits for a Class B digital device, pursuant to part 15 of the FCC Rules. These limits are designed to provide reasonable protection against harmful interference in a residential installation. This equipment generates, uses and can radiate radio frequency energy and, if not installed and used in accordance with the instructions, may cause harmful interference to radio communications. However, there is no guarantee that interference will not occur in a particular installation. If this equipment does cause harmful interference to radio or television reception, which can be determined by turning the equipment off and on, the user is encouraged to try to correct the interference by one or more of the following measures:



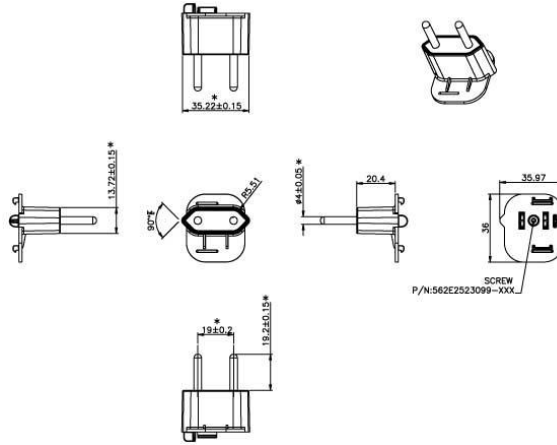

- Reorient or relocate the receiving antenna.
- Increase the separation between the equipment and receiver.
- Connect the equipment into an outlet on a circuit different from that to which the receiver is connected.
- Consult the dealer or an experienced radio/TV technician for help.

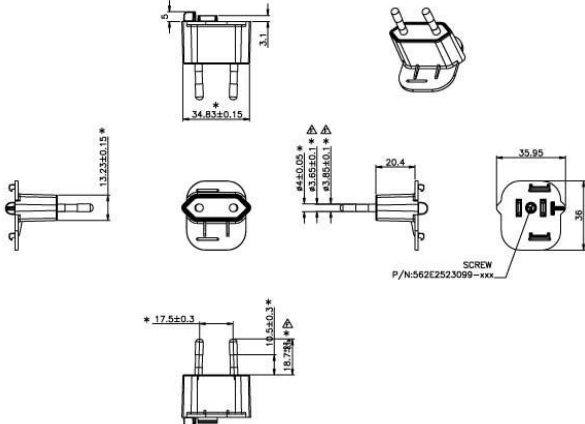
Changes or modifications to equipment not expressly approved by PHIHONG could void the user's authority to operate the equipment.

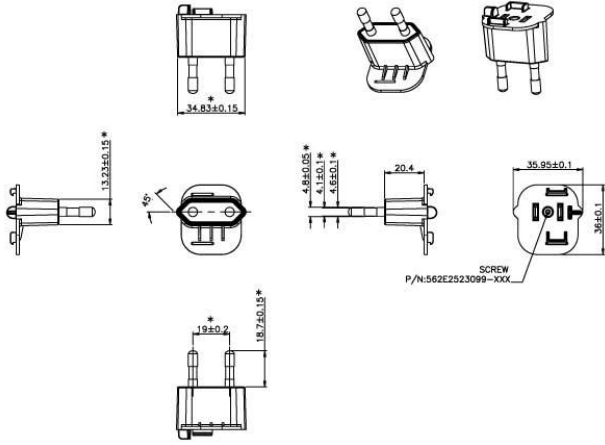

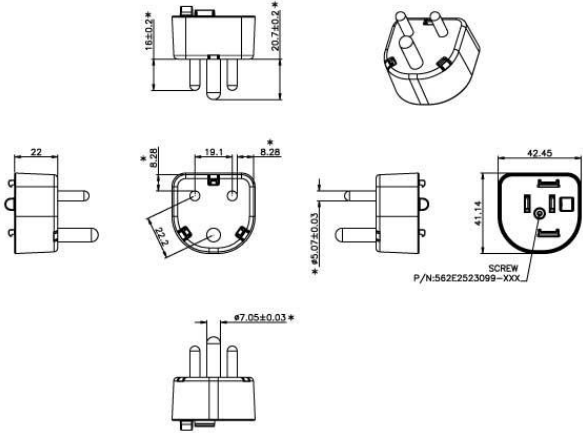
AC Input Clips - Sold Separately

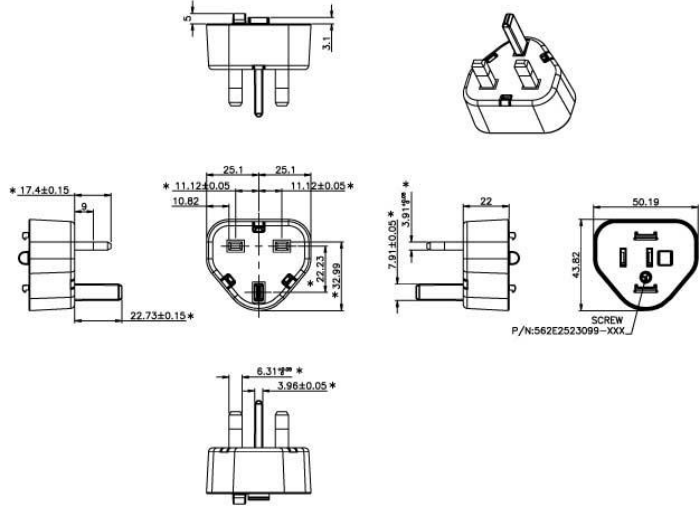
FPB-H – BRAZIL CLIP	Dimension Drawing Unit: mm
	
	
	

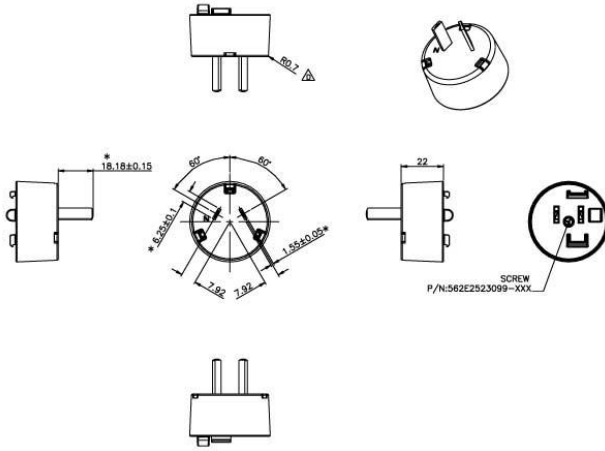
<p>FPI-H – INDIA CLIP</p> 	<p>Dimension Drawing Unit: mm</p> 
<p>FPK-H – UK CLIP</p> 	<p>Dimension Drawing Unit: mm</p> 
<p>FPN-H – ARGENTINA CLIP</p> 	<p>Dimension Drawing Unit: mm</p> 

FPBAG1-H

EU & UK CLIP





USB Cables – Sold Separately

Unit: mm

Part no: IP-USB1(C10)S	Desc: USB-A to Micro-B – 1 Meter – Black
Part no: IPUSB1CS	Desc: USB to Mini-B – 1.5 Meter – Black
Part no: IPUSB1MS	Desc: USB-A to Micro-B – 1.5 Meter – Black
Part no: IPUSB1M5LD	Desc: USB-A to Micro-B – 24AWG – Low Drop – 1.5 Meter – Black
Part no: IPUSB1P5	Desc: USB-A to Micro-B – 1 Meter – 24AWG – Black
Part no: IPUSB1P5W	Desc: USB-A to Micro-B – 1 Meter – 24AWG – White

Part no: IPUSB1MSW	Desc: USB-A to Micro-B – 1.5 Meter – White
Part no: UES-1001A160	Desc: Low Drop Type-C USB Cable – 1 Meter – 23AWG on Power – 30AWG on Data - Black
Part no: UES-1003A160	Desc: Low Drop Type-C USB Cable - 1 Meter – 23AWG on Power – 30AWG on Data - White