



# 5W USB Interchangeable Plug Adapter



## Features

- USB Socket
- Field Changeable AC Plugs – sold separately
- US DoE Level VI Efficiency Compliance
- Ecodesign/ErP Lot 7 (EU) 2019/1782 Compliance
- AS/NZS 4665.1-2005+A1:2009, AS/NZS 4665.2-2005+A1:2009 Compliance
- Low Leakage Current
- UL 94 V0 Flammability
- ROHS Compliance
- The charging scheme: Data Lines (Pins 2 and 3) Shorted

## Applications

- Wireless Communications
- Portable Equipment
- Peripherals
- Networking



# PSAI05R-050QL6-R Specifications<sup>1</sup>

Model		PSAI05R-050QL6-R
Output	DC Output Voltage	5.0V
	Max Current	1.0A
	Output Power	5.0W
	Regulation	± 5%
	Ripple & Noise P-P(max) <sup>2</sup>	200mV
Input	AC Input Voltage Range	90 to 264VAC
	AC Input Frequency	47 to 63Hz
	Input Current	0.3A (RMS) max for 115Vac/max load 0.15A (RMS) max for 230Vac/max load
	Inrush Current	45A max., 240VAC
	No Load Power Consumption at 115VAC Input	0.0221W
	No Load Power Consumption at 230VAC Input	0.0288W
	115VAC Average Efficiency <sup>3</sup>	75.28%
	230VAC Average Efficiency <sup>3</sup>	73.80%
	230VAC 10% Load Efficiency <sup>3</sup>	66.48%
	Leakage Current	0.02mA max for 240VAC, 50Hz
Protection	Over-Voltage	7.2V max
	Short Circuit	The output can be shorted permanently without damage. Output current not exceed 950mA(RMS).
	Over-Current	5A max
Environmental	Operating Temperature	0°C to +50°C
	Non-Operating Temperature	-40° to +85°C
	Operating Humidity	90% RH max
Safety Approvals and EMC	Dielectric Withstand (HI-POT)	Primary to Secondary: 3000VAC for 1min, 10mA
	Insulation Resistance	Primary to Secondary: >7M ohm for 500VDC
	Standards	cULus 62368-1, IEC 62368-1, AS/NZS 62368.1:2018
	EMI Emissions	FCC Part 15 Class B, CAN ICES-003(B)/NMB-003(B), EN 55032/CISPR 32 Class B Conducted and Radiated
	Harmonic Current Emissions	IEC 61000-3-2
	Voltage Fluctuations & Flicker	IEC 61000-3-3
	Immunity	EN 55035/CISPR 35: IEC 61000-4-2 (+/- 8kV air, +/-4kV contact), IEC 61000-4-3, IEC 61000-4-4, IEC 61000-4-5 (+/- 1kV), IEC 61000-4-6, IEC 61000-4-8, IEC 61000-4-11
Mechanical	Dimensions (L x W x H)	76.1mm (3.00in) x 45.8mm (1.80in) x 30.88mm (1.22in)
	DC Output Connector	USB Type A
Notes	<ol style="list-style-type: none"> <li>The specifications defined are at ambient temperature of 25°C, unless otherwise specified.</li> <li>20MHz bandwidth frequency oscilloscope, add a 0.1µF multilayer Cap. and Low ESR Electrolytic Cap. (10µF) at output connector terminals (nominal line voltage, full load).</li> <li>Efficiency is measured after 30 minutes burn-in.</li> </ol>	



# PSAI05R-050QL6-R Outline Drawing

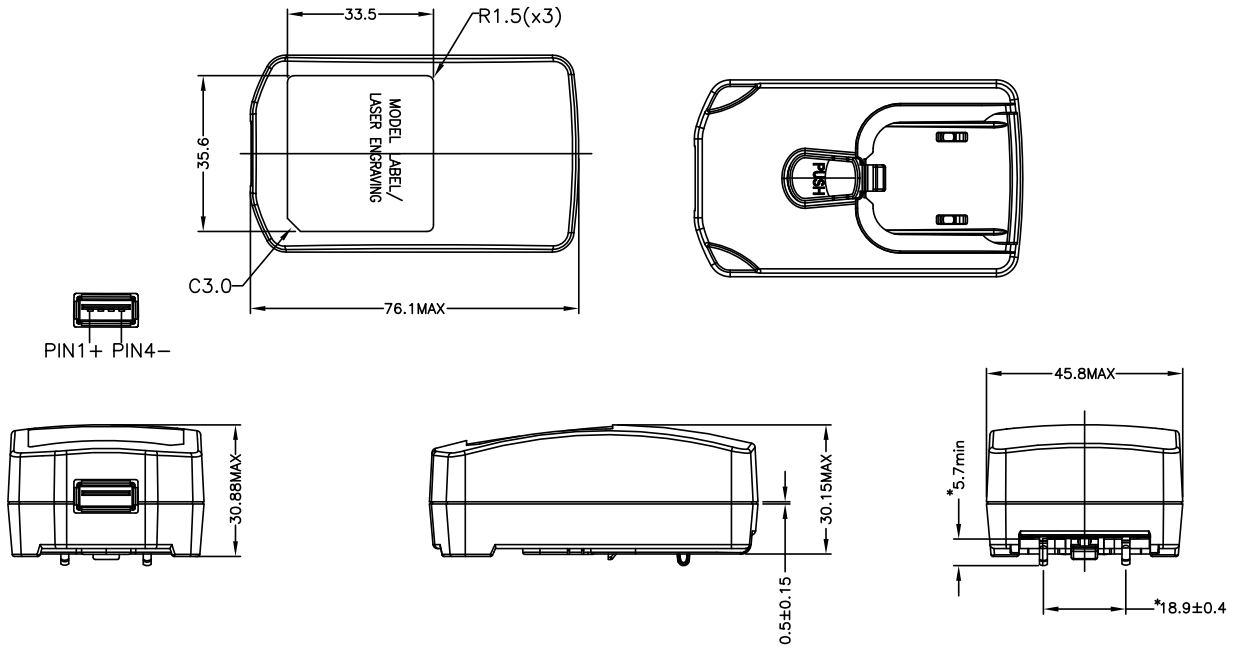



**Supplier's Declaration of Conformity**  
**47 CFR § 2.1077 Compliance Information**







Phihong USA Corporation  
47800 Fremont Boulevard  
Fremont, CA 94538  
Telephone: (510) 445-0100  
[www.phihong.com](http://www.phihong.com)

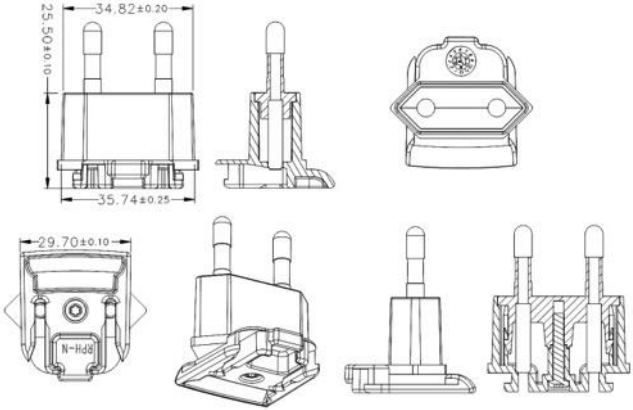

*This device complies with/The devices in this product series comply with part 15 of the FCC Rules. Operation is subject to the following two conditions: (1) This device may not cause harmful interference, and (2) this device must accept any interference received, including interference that may cause undesired operation.*

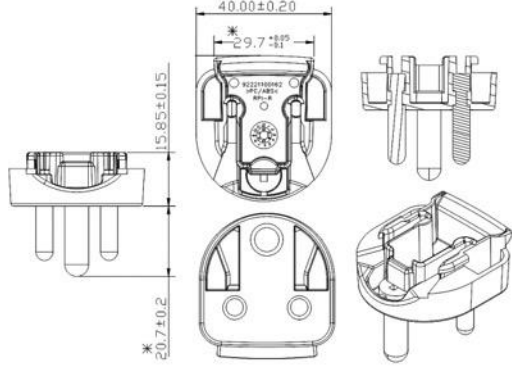

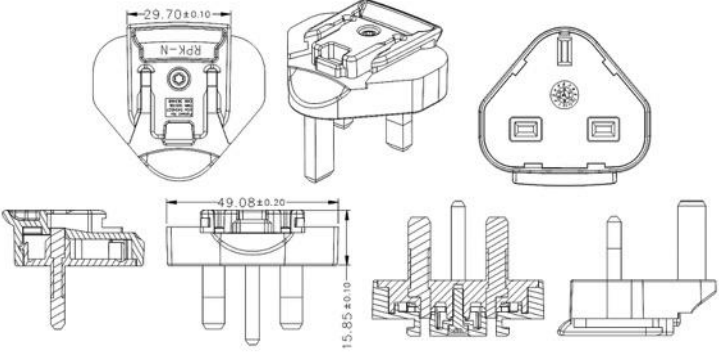
# AC Input Clips – Sold Separately

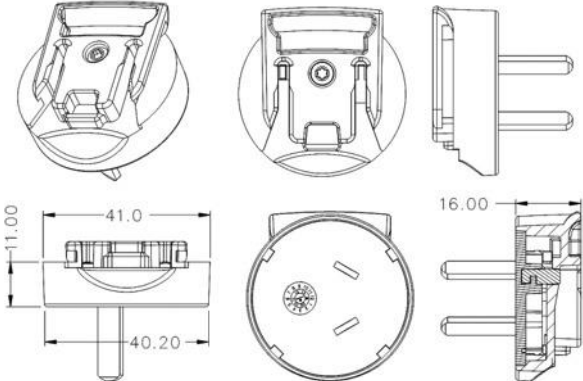
Model	Photo	Description	Outline Drawing - mm
RPA-AB01B-H		US Clip	
RPB-AB01B-H		Brazil Clip	
RPC-AB01B-H		China Clip	
RPE-AB01B-H		Europe Clip	

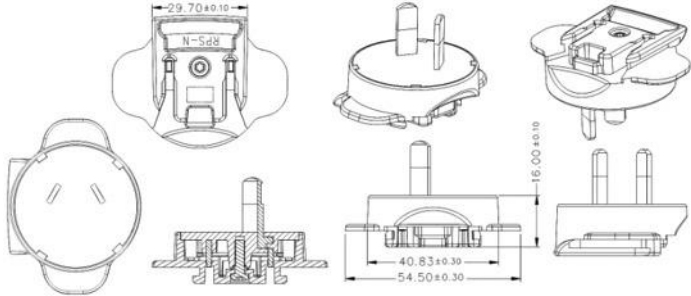
Model	Photo	Description	Outline Drawing - mm
RPH-AB01B-H		Korea Clip	
RPI-AB01B-H		India Clip	
RPK-AB01B-H		UK Clip	
RPN-AB01B-H		Argentina Clip	

Model	Photo	Description	Outline Drawing - mm
RPS-AB01B-H		Australia Clip	
RPBAG-AB01B-H	<p data-bbox="492 569 1536 596">Product package comes with RPA-AB01B-H, RPE-AB01B-H, RPK-AB01B-H and RPS-AB01B- in a plastic bag.</p> 		



# USB Cables – Sold Separately

## Unit: mm

Part no: IP-USB1(C10)S	Desc: USB-A to Micro-B – 1 Meter – Black
Part no: IPUSB1CS	Desc: USB to Mini-B – 1.5 Meter – Black
Part no: IPUSB1MS	Desc: USB-A to Micro-B – 1.5 Meter – Black
Part no: IPUSB1M5LD	Desc: USB-A to Micro-B – 24AWG – Low Drop – 1.5 Meter – Black
Part no: IPUSB1P5	Desc: USB-A to Micro-B – 1 Meter – 24AWG – Black
Part no: IPUSB1P5W	Desc: USB-A to Micro-B – 1 Meter – 24AWG – White



Part no: IPUSB1MSW	Desc: USB-A to Micro-B – 1.5 Meter – White
Part no: UES-1001A160	Desc: Low Drop Type-C USB Cable – 1 Meter – 23AWG on Power – 30AWG on Data - Black
Part no: UES-1003A160	Desc: Low Drop Type-C USB Cable - 1 Meter – 23AWG on Power – 30AWG on Data - White